

NOTES

Each tank has an inlet on the end and one on each side for added flexibility.

The inlets and outlet seals are Polylok Poly II High Pressure Pipe Seals.

Outlet Filter Assembly:
(Zabel A-1800 4x22 Filter, 8" PVC Riser, 8" PVC Cap and Tee Handle)

Concrete Inlet Riser Sold Separately.

Tank walls are 3" thick and the floor is 4" thick.

Total Weight: 12,500 LBS

Max Bury Depth: 6 FT

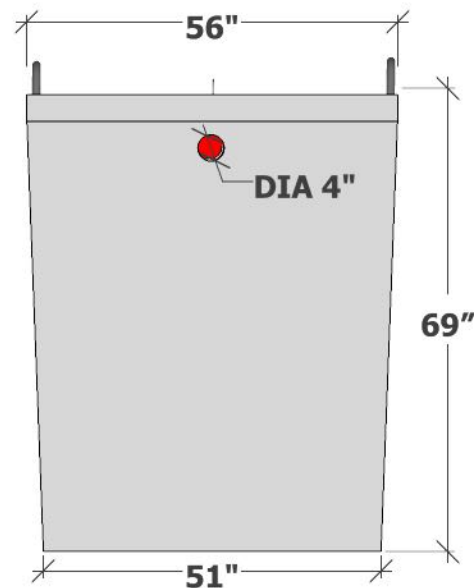

TITLE

1500 Gallon 1-Piece Septic Tank

DATE 08/18/17

REVISION 2.1

THE FAGENSTROM CO.
2101 NORTHWEST BYPASS
P.O. Box 2623
GREAT FALLS, MT 59403
WWW.FAGENSTROM.CO
406-761-5200



THE FAGENSTROM CO.

P.O. Box 2623
GREAT FALLS, MT 59403
(406) 761-5200

Recommended Septic Tank Installation Guidelines

1. Contact your local health department and obtain required permits and site plans.
2. Verify that the tank site is accessible for our delivery truck and that the cover over the tank will not exceed 6 feet. At least one end or one side of the hole must be accessible for our tank delivery truck to back up to it. This includes considerations for what's above and below the backup route, such as drain fields, underground sprinklers and overhead cables.
3. Excavate and set the grade of the inlet pipe.
4. Excavate the tank hole so that the bottom of the tank hole is at least 6" longer and wider than the tank dimensions. Grade the bottom of the hole to ensure it is level and firm.
5. The bedding under the tank should be a fine grained soil or aggregate less than 2" in size and at least 4" in depth. The bedding is to flat and uniform with no rocks, humps or depressions.
6. After the tank is in place, backfill and compact the trenches under the inlet and outlet pipes. Backfill should never be placed around the tank unless the lid is in place and properly sealed to the walls.
7. If mechanical or hydraulic compaction is used during backfill, the tank must be filled with water incrementally so that the liquid level in the tank is equal to, or slightly above, the level of the backfill around it.
8. No rocks, frozen chunks of soil, or other solid objects greater than 6 inches should be placed within 6" of the wall of the tank.
9. Stub the inlet and outlet pipes into the tank so that the tees are accessible from the access openings at the top of the tank.
10. Glue the inlet tee and outlet filter assembly to the pipes.
11. Install the clean-out riser so that the plug is between 4" and 12" below ground level.
12. Install filter access riser and the tee handle for the filter. The 1/2" pipe for the handle should be cut to length and attached to filter assembly. Then, glue the tee handle onto the pipe. The 8" plastic filter riser must extend above ground and be capped with a plastic cap that is secured with the set screw.
13. Backfill the tank maintaining positive drainage away from the tank.

1500 Gallon DelZotto Style Septic Tank

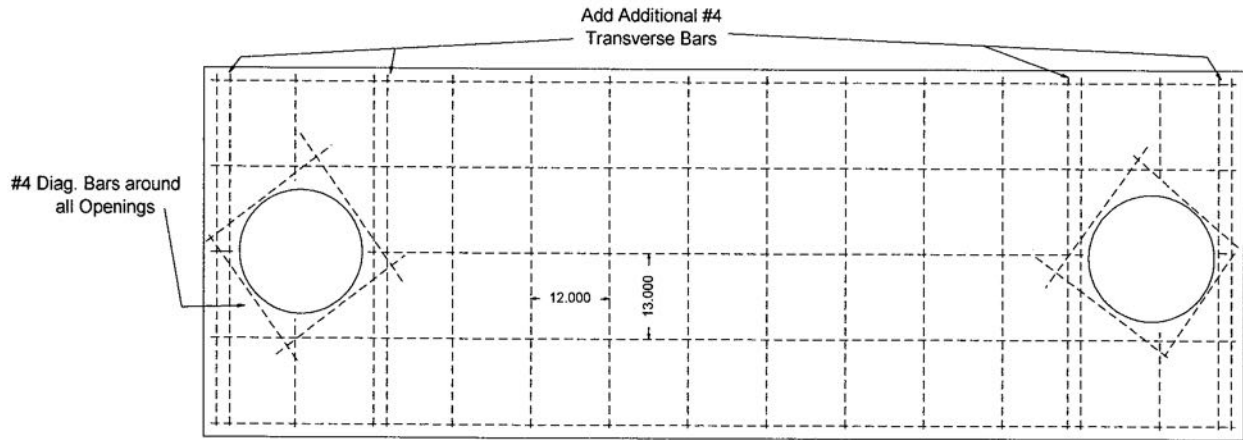

TOP VIEW of LID
 Longitudinal #4 Bars 13" OC
 Transverse #4 Bars 12" OC

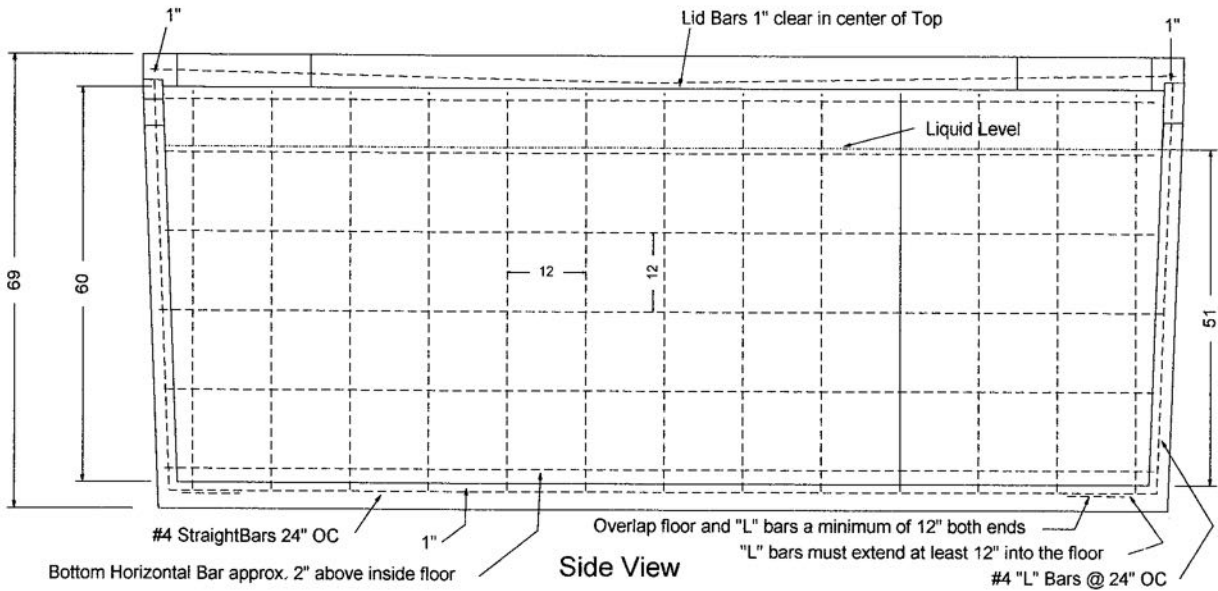

All Bars in walls and floor are 1" clear of inside of tank.

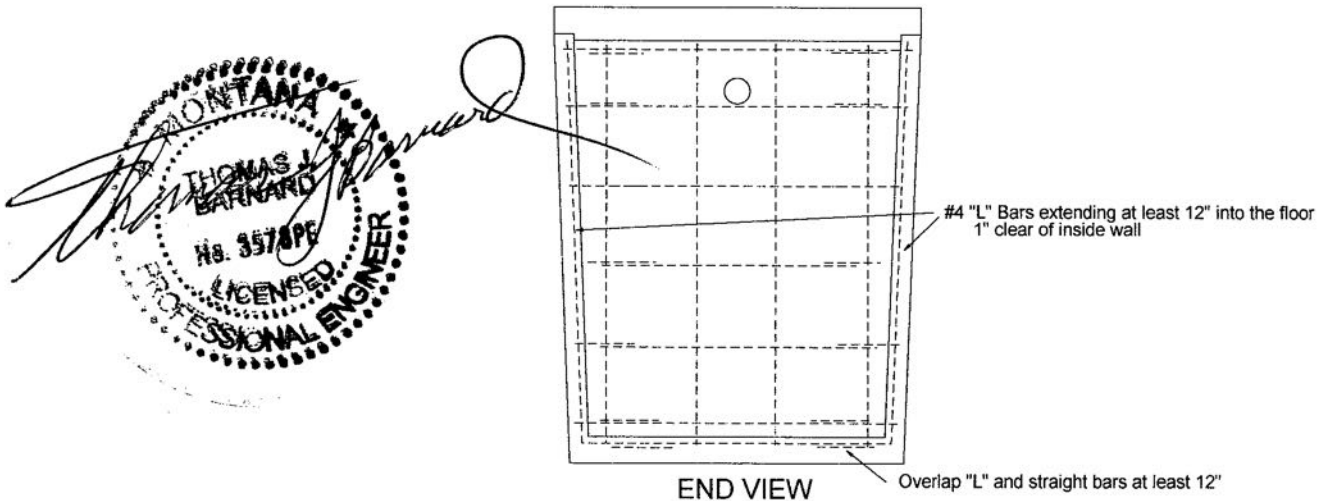

Tank Reinforcement
Tank Reinforcement for various concrete tanks has been designed for The Fagenstrom Company
Great Falls, Montana
(See Drawings for Details.)

THE REINFORCEMENT IS DESIGNED WITH CERTAIN CONDITIONS AS FOLLOWS

They are designed with for a maximum of 6 ft. of 120#/CF soil cover on the top of the tank. They are not designed for any other dead load or vehicular traffic of any kind except for those with an 8 inch thick Lid which is designed for a single 14,000 # wheel load.

Deformed Reinforcing Bars must be free of defects and have a nominal yield strength of 60,000 PSI.

The design is contingent upon proper back fill procedures as follows:

1. Backfill is never placed around the tank unless the Lid is in place and properly sealed to the walls.
2. If mechanical or hydraulic compaction is used during backfill, the tank must be filled with water incrementally so that the liquid level in the tank is equal to, or slightly above, the level of the backfill around it.
3. The tank is not to be filled with water unless the lid is properly sealed in place and backfill has been placed around it.
4. No rocks, frozen chunks of soil, or other solid objects greater than 6 inches are placed within 6" of the wall of the tank.
5. The bedding under the tank is a fine grained soil or aggregate less than 2" in size and at least 4" in depth. The bedding is to be level and uniform with no rocks, humps, or depressions.

Proper placement of the reinforcing is critical. It must be uniformly placed and with no more than 1" of depth from the inside of the walls, top of the floor, and bottom of the Lid.

THOMAS J. BARNARD 3578PE



Do Your Part, Be SepticSmart: The Do's and Don'ts of Your Septic System

Learn these simple steps to protect your home, health, environment and property value:



Protect It and Inspect It:

Do:

- Have your system inspected (in general) every three years by a licensed contractor and have the tank pumped, when necessary, generally every three to five years.

Think at the Sink:

Don't:

- Pour cooking grease or oil down the sink or toilet.
- Rinse coffee grounds into the sink.
- Pour household chemicals down the sink or flush them.

Do:

- Eliminate or limit the use of a garbage disposal.
- Properly dispose of coffee grounds & food.
- Put grease in a container to harden before discarding in the trash.

Don't Overload the Commode:

Don't:

- Flush non-degradable products or chemicals, such as feminine hygiene products, condoms, dental floss, diapers, cigarette butts, cat litter, paper towels, pharmaceuticals.

Do:

- Dispose of these items in the trash can!

Shield Your Field:

Don't:

- Park or drive on your drainfield. The weight can damage the drain lines.
- Plant trees or shrubs too close to your drainfield, roots can grow into your system and clog it.

Do:

- Consult a septic service professional to advise you of the proper distance for planting trees and shrubs, depending on your septic tank location.

Don't Strain Your Drain:

Don't

- Concentrate your water use by using your dishwasher, shower, washing machine, and toilet at the same time. All that extra water can really strain your septic system.

Do:

- Stagger the use of water-generating appliances. This can be helpful especially if your system has not been pumped in a long time.
- Become more **water efficient** by fixing plumbing leaks and consider installing bathroom and kitchen faucet aerators and water-efficient products.

For more SepticSmart tips, visit: www.epa.gov/septicSMART

Proper Landscaping On and Around Your Septic System

The drainfield is a vital part of your septic system. Having the right landscaping on and around your system is important, as tree and shrubbery roots can grow into the drain lines. Also, other heavy items like cars and livestock can break drain lines. Strong roots and heavy items can cause the drainfield to fail. And if the drainfield fails, your system fails.



Here are some tips to keep your drainfield out of harm's way.

Locate your septic tank and drainfield. Then make sure the area is clear of:

- Underground sprinkler lines
- Decks and patios
- Sports courts
- Storage sheds
- Swing sets
- Sand boxes
- Driveways
- Vehicles
- Swimming pools

Plant native, drought-tolerant plants. These are some of the best for your septic system and its drainfield:

Grass:

- Fescue
- Lawn
- Ornamental grasses
- Wildflower meadow mixes

Groundcovers for sun:

- Bugleweed (Ajuga)
- Carpet heathers (Calluna Vulgaris)
- Cotoneaster (Cotoneaster)
- Ground ivy (Glechoma)
- Kinnikinnick (Arctostaphylos)
- Periwinkle (Vinca)

Groundcovers for shade:

- Bunchberry (Cornus)
- Chameleon (Houttuynia)
- Ferns
- Mosses
- Sweet woodruff (Galium Odoratum)
- Wild ginger (Asarum)
- Wintergreen (Gaultheria)

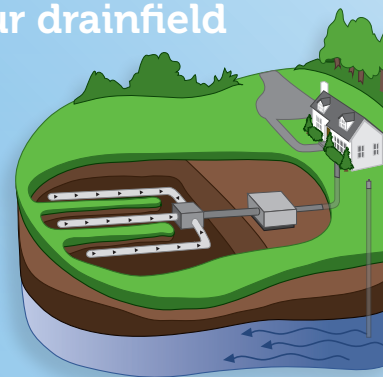

Follow Septic Sam's landscaping do's and don'ts:

Don't:

- Plant a vegetable garden on or near the drainfield.
- Put plastic sheets, bark, gravel or other fill over the drainfield.
- Reshape or fill the ground surface over the drainfield and reserve area. However, just adding topsoil is generally OK if it isn't more than a couple of inches.
- Make ponds on or near the septic system and the reserve area.

Do:

- Plant grass or keep existing native vegetation. These are the best covers for your drainfield.
- Direct all surface drainage away from the septic system.
- Use shallow-rooted plants (see plant list above). Tree and shrub roots can grow into the drainlines, clogging and breaking them.
- Avoid water-loving plants and trees.
- Make sure the tank lid is secure.

For more SepticSmart tips, visit www.epa.gov/septicSMART



A1800-4x18-B35 & B40



A1801-4x18



A1800-4x22-B35 & B40

A1801-4x22

INSTALLATION A1800™ Series Filter

New System Installation:

STEP 1

Locate the outlet of the septic tank.

Note: Make sure tank is installed level.

STEP 2

Remove the tank cover.

Solvent weld the outlet tee baffle onto the septic tank outlet pipe.

Optional Handle Installation Instructions

1. Place the 1/2" female threaded cap underneath the hole in the center of the filter handle.
2. Thread the male end of the 1/2" male adapter (MIPT x SLIP) into the female threads of the cap. Tighten the fittings until they are snug around the filter handle.
3. Glue one end of the 1/2" sch40 pipe into the slip adapter on the top of the filter. (If the 1" pipe is not long enough, you will need to supply your own length of pipe. Also, the pipe may be cut to give a shorter handle.)
4. Glue the 1/2" tee to the top of the 1/2" sch40 pipe.
5. Install the Zabel filter following its Installation Instructions. *Notes: Prime all fittings before solvent Welding (gluing).*

STEP 3

Insert A1801 cartridge into 4" tee baffle taking care that the security tab is facing the outlet opening in order to properly secure filter in place.

Security Tab

Existing System Installation

STEP 1

Locate the outlet of the septic tank.

STEP 2

Remove the tank cover and pump the tank if necessary to prevent any solids from escaping to the field when the cartridge is removed.

STEP 3

Before solvent welding (glueing), make sure that when installed the tee and filter will be centered under the access opening and that the filter is level.

If not attach additional pipe. Solvent weld the tee and pipe assembly to the 4" outlet pipe extending through the wall of the tank.

Note: Always clean and prime all pipe before solvent welding.

STEP 4

Insert the filter cartridge into the tee, making sure the filter cartridge is completely inserted into the tee.



Notes:

- If 4" PVC pipe does not extend into the tank, a plumbing flange may be used.
- The A1801 and A1801-HIP cartridges may be inserted into SDR 35 or Schedule 40 outlet tee baffles.
- The bottom gasket on the cartridge must be contained within the outlet baffle pipe, in order to create a seal with the surrounding pipe.
- If you have purchased a Zabel Smartfilter, additional installation instructions can be found in the Smartfilter Alarm System box.
- A riser to grade over the outlet access opening is recommended and may be required in certain states.
- If the filter can not be installed in the existing tank, it can be installed using a Zeus Basin System. In this case, the New System Installation instructions will be used.
- Filter material: white or natural = PVC, gray = ABS
- Performance: Maximum daily flow = 800 GPD
Average reduction in TSS within 6 months of installation - 40% in typical residential wastewater.
- Minimum of 3" drop required in tank for proper SmartFilter operation



MAINTENANCE

A1800™ Series Filter

The interval for servicing septic tanks is set by state and local code. Throughout the United States there is a wide difference of opinion on what this interval should be, but most regulatory agencies suggest two to five years. The Zabel® filter, which does not increase the frequency of servicing for the tank, should be cleaned when the septic tank is normally inspected and pumped. However, our filter is virtually self-cleaning. The continued action of the anaerobic organisms on the Zabel filter causes lodged particles to disintegrate and fall to the bottom of the tank. If your filter contains a SmartFilter® alarm, you will be notified by an alarm when the filter needs servicing.



To service the filter:

**Servicing any Zabel filter should only be done by a certified septic tank pumper or installer.*

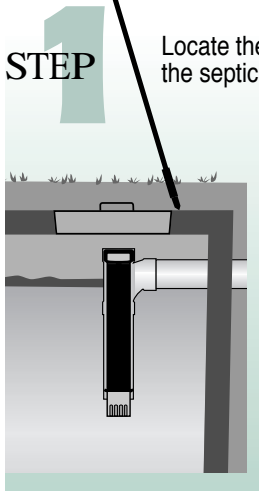

STEP 1

Locate the outlet of the septic tank.

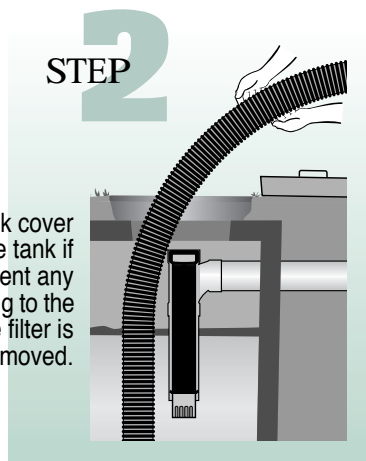

STEP 2

Remove the tank cover and pump the tank if necessary to prevent any solids from escaping to the field when the filter is removed.

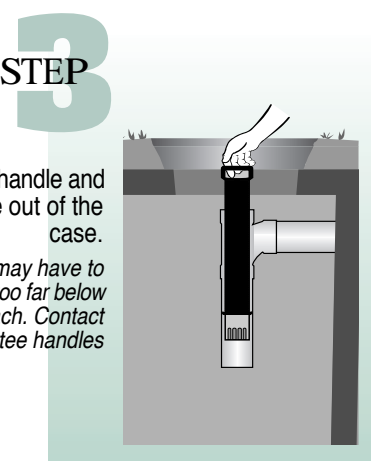

STEP 3

Firmly pull the filter handle and slide the cartridge out of the case.

**Note: A tee handle may have to be used if the filter is too far below ground level to reach. Contact Zabel for info on tee handles*

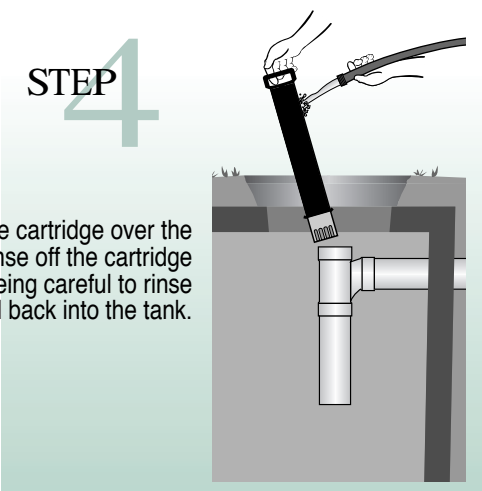

STEP 4

While holding the cartridge over the access opening rinse off the cartridge with fresh water, being careful to rinse all septage material back into the tank.

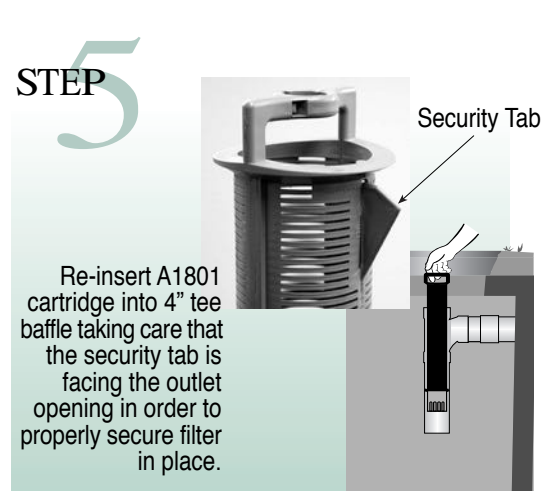

STEP 5

Re-insert A1801 cartridge into 4" tee baffle taking care that the security tab is facing the outlet opening in order to properly secure filter in place.

Security Tab

Notes:

- If you have a Filtered Versa-Tee™ Model Filter, be sure and spray clean the outlet opening before replacing the Filter.



The product(s) shown are covered by the following patents:

Copyright 2003, Zabel Industries International, Ltd. All rights reserved

Product(s) covered by one or more U.S. and/or International patents. Other U.S. and International patents may be pending.

Call for a free ZABEL ZONE® 1-800-221-5742 • Or Order Online: www.zabelzone.com